

TS 101 392 V6.0.0 (1998-10)

Technical Specification

**Digital cellular telecommunications system (Phase 2+);
Signalling interworking between ISDN supplementary
services;
Application Service Element (ASE) and
Mobile Application Part (MAP) protocols
(GSM 09.13 version 6.0.0 Release 1997)**



GSM®
GLOBAL SYSTEM FOR
MOBILE COMMUNICATIONS



ETSI

Reference

DTS/SMG-030913Q6 (cw003003.PDF)

Keywords

Digital cellular telecommunications system,
Global System for Mobile communications (GSM)

ETSI

Postal address

F-06921 Sophia Antipolis Cedex - FRANCE

Office address

650 Route des Lucioles - Sophia Antipolis
Valbonne - FRANCE
Tel.: +33 4 92 94 42 00 Fax: +33 4 93 65 47 16
Siret N° 348 623 562 00017 - NAF 742 C
Association à but non lucratif enregistrée à la
Sous-Préfecture de Grasse (06) N° 7803/88

Internet

secretariat@etsi.fr
<http://www.etsi.org>

Copyright Notification

No part may be reproduced except as authorized by written permission.
The copyright and the foregoing restriction extend to reproduction in all media.

© European Telecommunications Standards Institute 1998.
All rights reserved.

Contents

Intellectual Property Rights.....	4
Foreword	4
1 Scope.....	5
2 Normative references	5
3 Definitions and abbreviations	6
3.1 Definitions	6
3.2 Abbreviations.....	6
4 General	6
4.1 GSM CCBS Architecture Overview	6
4.2 GSM CCBS - ISDN CCBS ASE Interworking Overview	7
4.3 Overview on the use of CCBS procedures and parameters values.....	8
4.4 Mapping between MAP and SSAP application layer messages.....	8
4.4.1 MAP D-interface to SSAP interface mapping in HLR A	8
4.4.2 SSAP interface to MAP D-interface interface mapping in HLR A	8
5 Mapping between MAP message parameters and SSAP message parameters.....	9
5.1 CCBS Request Invocation	9
5.1.1 Encoding of called party subaddress information.....	11
5.2 CCBS Request Result	11
5.3 CCBS Request Error.....	12
6 Dialogue handling on the SSAP interface.....	13
6.1 Dialogue Beginning	13
6.1.1 CCBS Request Invocation.....	13
6.2 Dialogue Continuation	13
6.2.1 CCBS Request Result.....	13
6.2.2 CCBS Remote User Free Invocation.....	14
6.2.3 CCBS Suspend Invocation	14
6.2.4 CCBS Resume Invocation	15
6.3 Dialogue End	15
6.3.1 Normal dialogue end	15
6.3.2 CCBS Cancel Invocation (from A-side).....	16
6.3.3 CCBS Cancel Invocation (from B-side).....	16
6.3.4 CCBS Request Error	17
7 Addressing of SCCP layer messages on the SSAP interface.....	17
7.1 Use of SCCP	17
7.2 Addressing of messages at the originating PLMN	17
7.2.1 TC-BEGIN message from the originating network HLR	17
7.2.2 TC-CONTINUE, TC-END messages from the originating network HLR	18
7.3 Addressing of messages at the destination PLMN	18
7.3.1 TC-CONTINUE, TC-END messages from the destination network HLR	18
7.4 Number formats of the SCCP address parameters	19
7.4.1 Originating PLMN	19
7.4.2 Destination PLMN	19
Annex A (informative): Status of Technical Specification GSM 09.13	20
History	21

Intellectual Property Rights

IPRs essential or potentially essential to the present document may have been declared to ETSI. The information pertaining to these essential IPRs, if any, is publicly available for **ETSI members and non-members**, and can be found in SR 000 314: *"Intellectual Property Rights (IPRs); Essential, or potentially Essential, IPRs notified to ETSI in respect of ETSI standards"*, which is available **free of charge** from the ETSI Secretariat. Latest updates are available on the ETSI Web server (<http://www.etsi.org/ipr>).

Pursuant to the ETSI IPR Policy, no investigation, including IPR searches, has been carried out by ETSI. No guarantee can be given as to the existence of other IPRs not referenced in SR 000 314 (or the updates on the ETSI Web server) which are, or may be, or may become, essential to the present document.

Foreword

This Technical Specification (TS) has been produced by the Special Mobile Group (SMG) of the European Telecommunications Standards Institute (ETSI).

This specification provides a detailed specification for interworking between the ISDN Supplementary Services ASE protocol and the Mobile Application Part (MAP) D interface protocol for handling of supplementary services within the digital cellular telecommunications system.

The contents of this TS are subject to continuing work within SMG and may change following formal SMG approval. Should SMG modify the contents of this TS it will then be republished by ETSI with an identifying change of release date and an increase in version number as follows:

Version 6.x.y

where:

- 6 indicates GSM Phase 2+ Release 97;
- x the second digit is incremented for all other types of changes, i.e. technical enhancements, corrections, updates, etc.;
- y the third digit is incremented when editorial only changes have been incorporated in the specification.

1 Scope

The scope of this Technical Specification is to provide a specification for interworking between the ISDN Application Service Element (ASE) protocol for supplementary services and the Mobile Application Part (MAP) protocol on MAP D-interface protocol for handling of supplementary services within the digital cellular telecommunications system (Phase 2+). This version of the specification includes the interworking for the Call Completion to Busy Subscriber (CCBS) service between the ISDN CCBS-ASE and MAP.

The MAP protocol for CCBS service is specified in GSM 09.02. The ISDN CCBS-ASE protocol is specified in ETS 300 356-18. The ISDN CCBS-ASE protocol is also commonly referred to as the SSAP protocol in GSM 03.93. This specification clarifies the interworking within the HLR between these protocols for the Call Completion to Busy Subscriber (CCBS) service.

Clause 4 describes the mapping between MAP application layer messages and SSAP application layer messages.

Clause 5 describes the mapping between MAP message parameters and SSAP message parameters.

Clause 6 describes the dialogue handling on the SSAP interface.

Clause 7 describes the SCCP layer addressing for messages on the SSAP interface.

2 Normative references

The following documents contain provisions which, through reference in this text, constitute provisions of the present document.

- References are either specific (identified by date of publication, edition number, version number, etc.) or non-specific.
- For a specific reference, subsequent revisions do not apply.
- For a non-specific reference, the latest version applies.
- A non-specific reference to an ETS shall also be taken to refer to later versions published as an EN with the same number.

- [1] GSM 01.04: "Digital cellular telecommunications system (Phase 2+); Abbreviations and acronyms".
- [2] GSM 02.93: "Digital cellular telecommunications system (Phase 2+); Completion of calls to busy subscriber (CCBS) supplementary services - Stage 1".
- [3] GSM 03.93: "Digital cellular telecommunications system (Phase 2+); Technical Realisation of Completion of Calls to Busy Subscriber (CCBS); Stage 2".
- [4] GSM 04.80: "Digital cellular telecommunications system (Phase 2+); Mobile radio interface layer 3 supplementary services specification Formats and coding".
- [5] GSM 04.93: "Digital cellular telecommunications system (Phase 2+); Technical Realisation of Completion of Calls to Busy Subscriber (CCBS); Stage 3".
- [6] GSM 09.02 "Digital cellular telecommunications system (Phase 2+); Mobile Application Part (MAP) specification".
- [7] GSM 09.07 : "Digital cellular telecommunications system (Phase 2+); General requirements on interworking between the Public Land Mobile Network (PLMN) and the Integrated Services Digital Network (ISDN) or Public Switched Telephone Network (PSTN)".
- [8] ETS 300 102-1 (1990): "Integrated Services Digital Network (ISDN); User-network interface layer 3 specifications for basic call control".

- [9] ETS 300 356-18: "ISDN User Part (ISUP) version 2 for the international interface: Part 18: Completion of Calls to Busy Subscriber (CCBS) supplementary service".
- [10] ETS 300 358: "Integrated Services Digital Network (ISDN); Completion of Calls to Busy Subscriber (CCBS) supplementary service; Functional capabilities and information flows".

3 Definitions and abbreviations

3.1 Definitions

For the purposes of this specification, the following definitions apply:

SSAP: Supplementary Service Application Part. SSAP is the protocol used for CCBS procedures on the interface between the originating and destination network. Communication across this interface is performed using SCCP Connectionless Signalling (Refer to ETS 300 358). The terms CCBS-ASE defined in ETS 300 356-18 for the ISDN CCBS service and SSAP defined in GSM 03.93 are the same and are used interchangeably in this specification. The SSAP interface is between the originating network entities (HLR A, OLE) and the destination network entities (HLR B, DLE).

3.2 Abbreviations

Abbreviations used in this specification are listed in GSM 01.04.

For the purposes of this specification, the following abbreviations apply:

ASE	Application Service Element
CCBS	Call Completion to Busy Subscriber
DLE	Destination Local Exchange
ISDN	Integrated Services Digital Network
MAP	Mobile Application Part
OLE	Originating Local Exchange
SCCP	Signalling Connection Control Part
SSAP	Supplementary Service Application Part
TC	Transaction Capabilities

4 General

4.1 GSM CCBS Architecture Overview

The stage 1 of the CCBS service is defined in GSM 02.93.

The network architecture to support the CCBS service in GSM networks is defined in GSM 03.93. For convenience, the architecture is shown again in this specification. Figure 4.1.1 is an architectural overview of the CCBS service when interworking between the originating and the destination networks involved. The originating network may be a mobile network or a fixed network and the destination network may also be a mobile network or a fixed network.

The call related signalling (see ETS 300 356-18) for CCBS is performed on ISUP links on the following interfaces:

- VMSC A - GMSC B;
- VMSC A - DLE;
- OLE - GMSC B;

whereas the specific CCBS procedures (see ETS 300 356-18) are performed via the SSAP protocol, which is signalled on the following interfaces:

- HLR A - HLR B;
- HLR A - DLE;
- OLE - HLR B.

This specification only describes the MAP - SSAP protocol interworking.

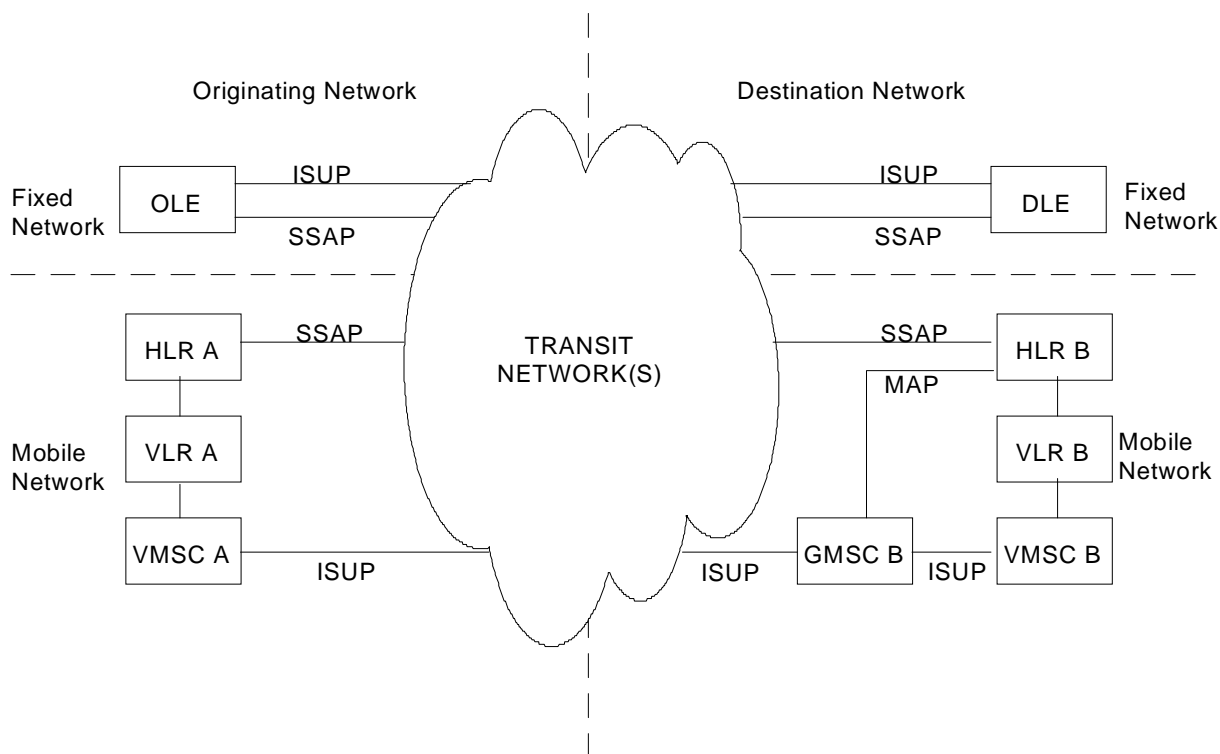

Figure 4.1: Architectural overview showing common point of interworking

4.2 GSM CCBS - ISDN CCBS ASE Interworking Overview

The non-call related signalling procedures for CCBS between the originating network and the destination network are defined in ETS 300 356-18 as the ISDN CCBS-ASE. The GSM network also uses these signalling procedures for CCBS without any changes. The ISDN CCBS ASE protocol is supported in GSM networks in the HLR A (originating network) and HLR B (destination network). Therefore no protocol interworking for ISDN CCBS-ASE is needed for the CCBS service between GSM networks and ISDN networks.

In GSM networks, the CCBS functionality is distributed across several network entities (see GSM 03.93) including the HLR, VLR, MSC and the MS. The HLR shall provide any necessary signalling interworking between the MAP protocol for call completion services on the MAP D-interface (between the VLR and the HLR) and ISDN CCBS-ASE protocol between the originating and destination networks.

The MAP protocol for CCBS service is specified in GSM 09.02. The ISDN CCBS-ASE protocol is specified in ETS 300 356-18. This specification clarifies the interworking within the HLR between these protocols.

4.3 Overview on the use of CCBS procedures and parameters values

A GSM subscriber can roam while there is an active CCBS request. The called party address (MSISDN) information is used to initiate a dialogue with the destination network on the SSAP interface. The dialogue on the SSAP interface is opened and maintained while there is an active CCBS request (see ETS 300 356-18). However, the dialogues on the MAP D interface can be closed and reopened as necessary (see GSM 09.02 and GSM 03.93) and use the IMSI information for addressing.

4.4 Mapping between MAP and SSAP application layer messages

The mapping of MAP messages on the D interface and SSAP messages between the originating and destination networks is described. The precise coding of these messages is given in GSM 09.02 and ETS 300 356-18.

4.4.1 MAP D-interface to SSAP interface mapping in HLR A

Table 4.1: Mapping of GSM 09.02 (MAP) operations to ETS 300 356-18 (SSAP) operations

MAP OPERATIONS	SSAP OPERATIONS
RegisterCCEnter	CcbsRequest
EraseCCEnter/ A GSM 03.93 Event (note 1)	CcbsCancel
RemoteUserFree Result/ RemoteUserFree Error/ A GSM 03.93 Event (note 2)	CcbsSuspend
StatusReport/ A GSM 03.93 Event (note 3)	CcbsResume
NOTE 1	This event may be local to HLR A. See GSM 03.93 for a dynamic description of possible events in HLR A leading to a CCBS request being cancelled. The SSAP CcbsCancel operation can include a cause code parameter; this shall be set to the appropriate value corresponding to the actual dynamic event by HLR A (e.g. cCBS-T3-Timeout, cCBS-T4-Timeout).
NOTE 2	This event may be local to HLR A. See GSM 03.93 for a dynamic description of possible events in HLR A leading to a CCBS request being suspended.
NOTE 3	This event may be local to HLR A. See GSM 03.93 for a dynamic description of possible events in HLR A leading to a CCBS request being resumed.

4.4.2 SSAP interface to MAP D-interface interface mapping in HLR A

SSAP OPERATIONS	MAP OPERATIONS
CcbsRequest Result	RegisterCCEnter Result
CcbsRequest Error	RegisterCCEnter Error
RemoteUserFree	RemoteUserFree
CcbsCancel	SetReportingState/A GSM 03.93 Event (note 1)
NOTE 1	This event may be local to HLR A. See GSM 03.93 for a dynamic description of possible events in HLR A resulting from a CCBS request being cancelled. The SSAP CcbsCancel operation can include a cause code parameter(e.g. cCBS-T7-Timeout, cCBS-T9-Timeout).

5 Mapping between MAP message parameters and SSAP message parameters

The mapping between MAP message parameters and SSAP message parameters is described. The precise coding of these messages is given in GSM 09.02 and ETS 300 356-18.

The following messages on the SSAP interface do not contain any parameters:

- RemoteUserFree;
- Suspend;
- Resume.

5.1 CCBS Request Invocation

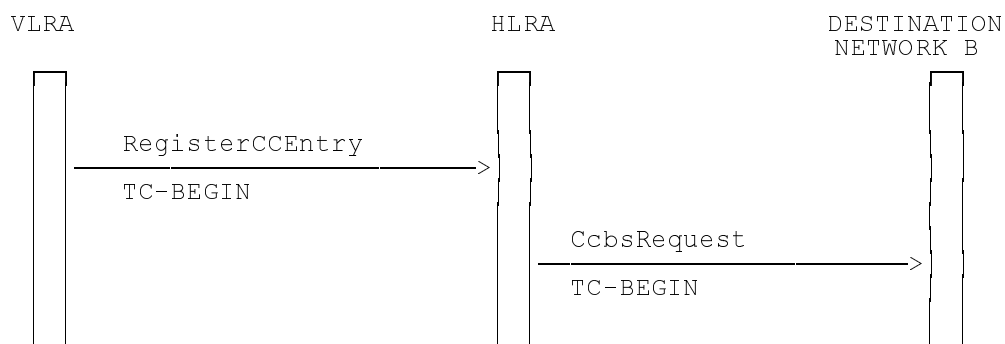

Figure 5.1: Signalling flow for CCBS Request Invocation

Table 5.1: Mapping of CCBS Request Invocation parameters

RegisterCCEntry PARAMETERS	CcbsRequest PARAMETERS
ss-Code	not present
ccbs-Feature	
- b-subscriberSubaddress (note 1)	accessTransportParameter (note 2)
translatedB-Number	calledPartyNumber (note 3)
serviceIndicator	not present
callInfo	not present
networkSignalInfo	
- ISDN BC Tag, Length, Content (note 4)	userServiceInf
networkSignalInfo	
- HLC Tag, Length, Content (note 5)	accessTransportParameter (note 2)
networkSignalInfo	
- LLC Tag, Length, Content (note 6)	accessTransportParameter (note 2)
not present	retainSupported (note 7)
not present	callingPartyNumber (note 8)
not present	userServiceInfPrime (note 9)
NOTE 1	CCBS-Feature contains the b-subscriberSubaddress parameter which is the called party subaddress. The GSM HLR A shall map the called party subaddress into the accessTransportParameter if received from the VLR. The entire called party subaddress information (i.e. called party subaddress IEI, LENGTH and CONTENT) is mapped into the accessTransportParameter. See subclause 5.1.1. for details of the required encoding.
NOTE 2	The CcbsRequest contains only one accessTransportParameter. This parameter contains information on the ISDN HLC, LLC and Subaddress.
NOTE 3	The calledParty Number shall be in the international E.164 format.
NOTE 4	The networkSignalInfo contains three information elements ISDN BC, HLC, LLC. The structure of this is defined in GSM 09.02 and the content in GSM 09.07. The entire ISDN BC information element (i.e. ISDN BC TAG, LENGTH and CONTENT) is mapped into the userServiceInf parameter.
NOTE 5	The networkSignalInfo contains three information elements ISDN BC, HLC, LLC. The structure of this is defined in GSM 09.02 and the content in GSM 09.07. The entire ISDN HLC information element (i.e. ISDN HLC TAG, LENGTH and CONTENT) is mapped into the accessTransportParameter.
NOTE 6	The networkSignalInfo contains three information elements ISDN BC, HLC, LLC. The structure of this is defined in GSM 09.02 and the content in GSM 09.07. The entire ISDN LLC information element (i.e. ISDN LLC TAG, LENGTH and CONTENT) is mapped into the accessTransportParameter.
NOTE 7	This information is local to the HLR A. This information element shall be coded by HLR A to reflect whether it supports CCBS Retention capability.
NOTE 8	This information is local to HLR A. The HLR A provides callingPartyNumber if CLIR was not invoked (See the serviceIndicator parameter in GSM 09.02 and GSM 03.93). If sent, the A subscriber's identity shall be the Basic MSISDN (i.e. the main MSISDN) and shall be in the international E.164 format.
NOTE 9	The GSM HLR A shall not send the userServiceInfPrime

5.1.1 Encoding of called party subaddress information

The CCBS-Feature parameter is received from the VLR and it may include the b-subscriberSubaddress parameter as defined in GSM 09.02. The Called Party Subaddress information requires additional processing in HLR to ensure correct encoding of this information on the SSAP interface. The HLR shall add two octets to the ISDN-SubaddressString received from the VLR as indicated in figure 5.2.

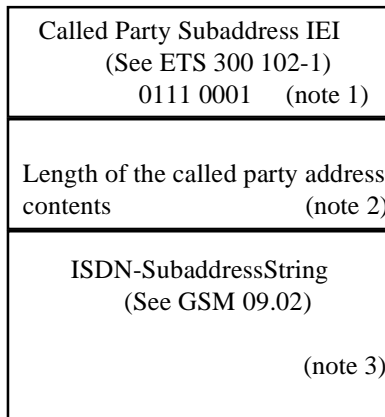

NOTE 1 Called Party Subaddress Information Element Identifier (IEI) is defined by ETS 300 102-1. Its value is "01110001". This information is not sent from the VLR and has to be derived locally in the HLR for interworking purposes.

NOTE 2 This information has to be derived locally in the HLR for interworking purposes.

NOTE 3 This information is sent by the VLR. The ISDN-SubaddressString contents is defined in GSM 09.02.

Figure 5.2: Encoding of Called Party Subaddress information

5.2 CCBS Request Result

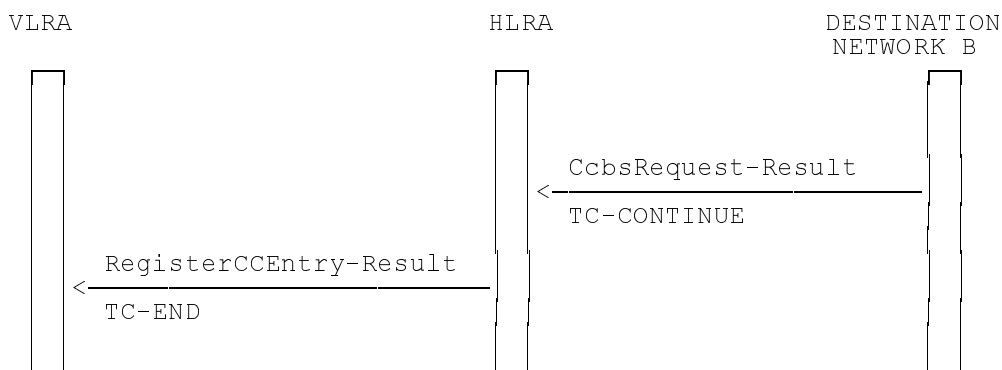

Figure 5.3: Signalling flow for CCBS Request Result

Table 5.2: Mapping of CCBS Request Result parameters

CcbsRequest_Result PARAMETERS	RegisterCCEntry_Result PARAMETERS
retainSupported (note 1)	not present
not present	ccbs-Feature (note 2)
NOTE 1	This information is associated with each CCBS Request and indicates whether CCBS Retention is supported by the destination B network (see GSM 03.93).
NOTE 2	This information is local to the HLR A. Some of information contained in ccbs-Feature (e.g. ccbs-index) is allocated by the HLR A. The ccbs-Feature information is sent to the MS (see GSM 03.93, GSM 04.93).

5.3 CCBS Request Error

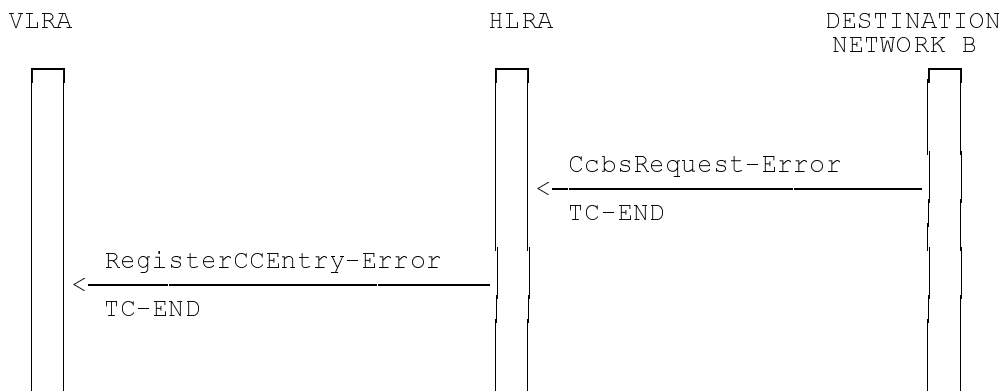

Figure 5.4: Signalling flow for CCBS Request Error

Table 5.3: Mapping of CCBS Request Error parameters

CcbsRequest_Error PARAMETERS	RegisterCCEntry_Error PARAMETERS
shortTermDenial/ longTermDenial (note 1)	shortTermDenial/ longTermDenial (note 2)
NOTE 1	For coding of these User Errors see ETS 300 356-18.
NOTE 2	For coding of these User Errors see GSM 09.02. This information is sent to the MS (see GSM 04.93, GSM 04.80).

6 Dialogue handling on the SSAP interface

The dialogue handling on the SSAP interface and the mapping between the corresponding TC transaction sublayer messages on the MAP D and SSAP interfaces is described. The diagrams show the general principle of dialogue handling. Specific message flows depend on the dynamics of the application in the network elements, see GSM 03.93 and GSM 09.02.

6.1 Dialogue Beginning

6.1.1 CCBS Request Invocation

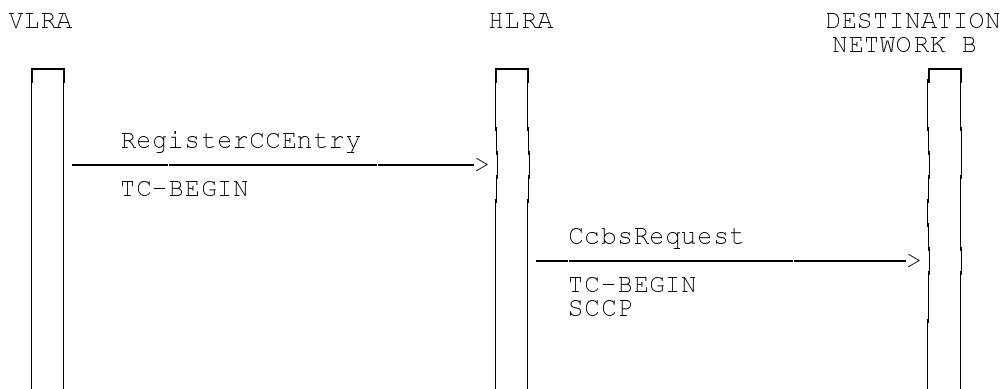

Figure 6.1: Signalling flow for CCBS REQUEST INVOCATION

The CCBS Request invocation is carried by TC-BEGIN. The SCCP addressing parameters on the SSAP interface shall be as shown in table 7.1.

6.2 Dialogue Continuation

6.2.1 CCBS Request Result

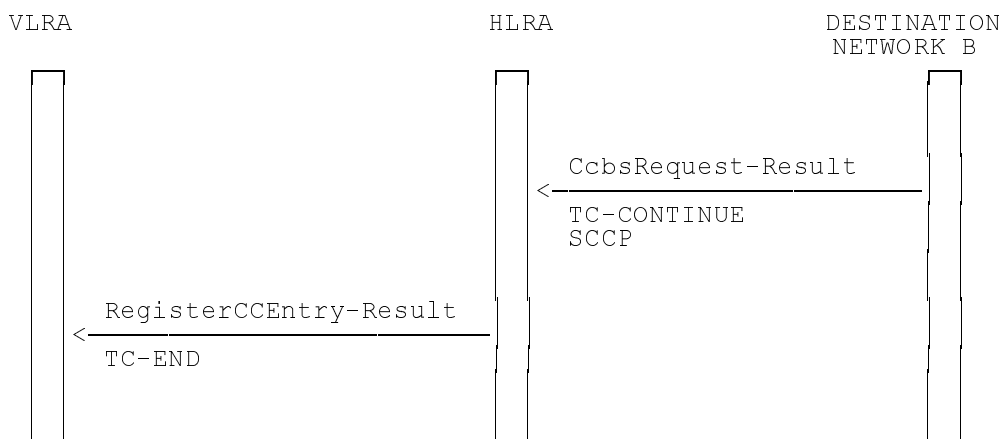

Figure 6.2: Signalling flow for CCBS Request Result

The CCBS Request Result is carried by TC-CONTINUE. The SCCP addressing parameters on the SSAP interface shall be as shown in table 7.3.

6.2.2 CCBS Remote User Free Invocation

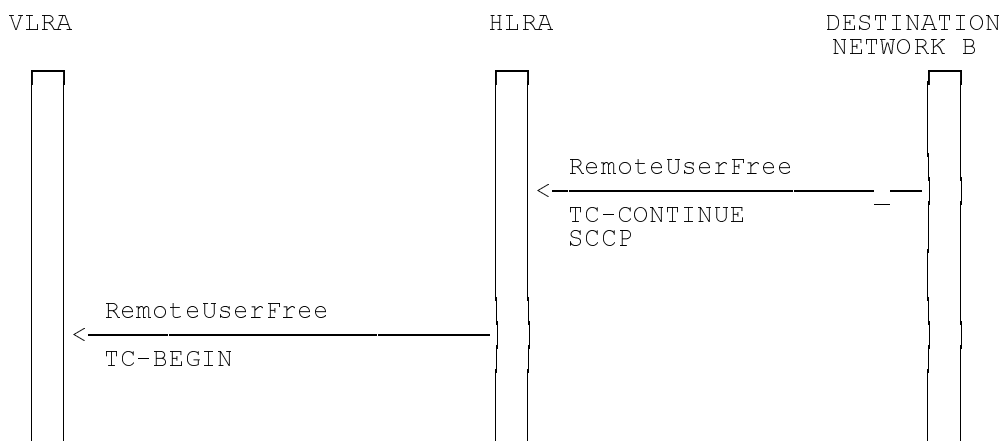
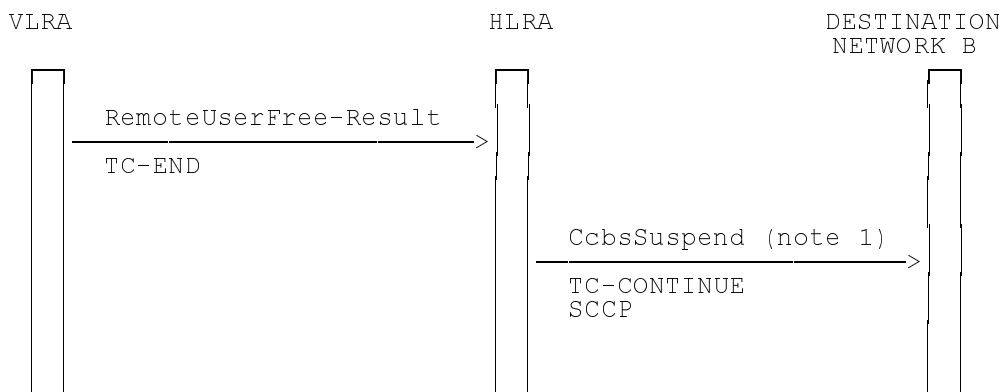

Figure 6.3: Signalling flow for Remote User Free Invocation

The CCBS Remote User Free Invocation is carried by TC-CONTINUE. The SCCP addressing parameters on the SSAP interface shall be as shown in table 7.3.

6.2.3 CCBS Suspend Invocation



NOTE 1 For conditions leading to a request being suspended, see GSM 03.93

Figure 6.4: Signalling flow for CCBS Suspend Invocation (RemoteUserFree_Result)

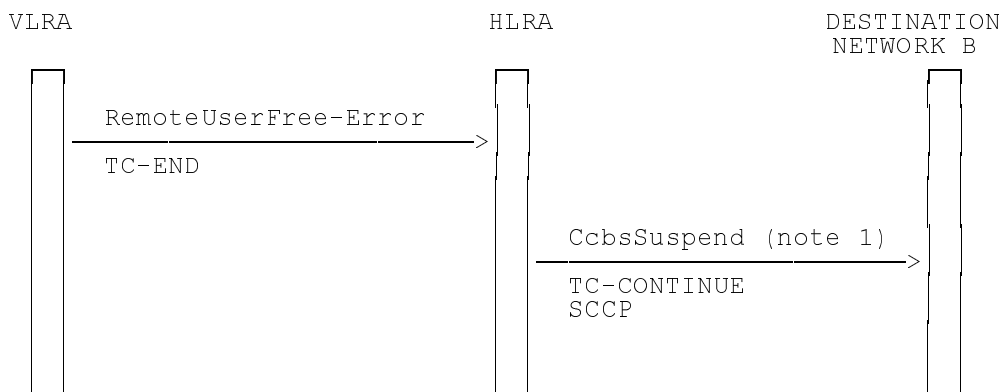

NOTE 1 For conditions leading to a request being suspended, see GSM 03.93

Figure 6.5: Signalling flow for CCBS Suspend Invocation (RemoteUserFree_Error)

The CCBS Suspend Invocation is carried by TC-CONTINUE. The SCCP addressing parameters on the SSAP interface shall be as shown in table 7.2

6.2.4 CCBS Resume Invocation

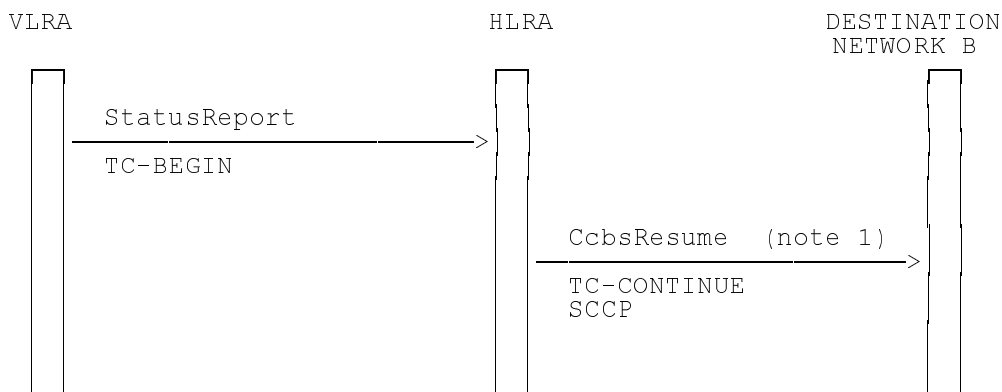

NOTE 1 For conditions leading to a request being resumed, see GSM 03.93

Figure 6.6: Signalling flow for CCBS Resume Invocation

The CCBS Resume Invocation is carried by TC-CONTINUE. The SCCP addressing parameters on the SSAP interface shall be as shown in table 7.2.

6.3 Dialogue End

6.3.1 Normal dialogue end

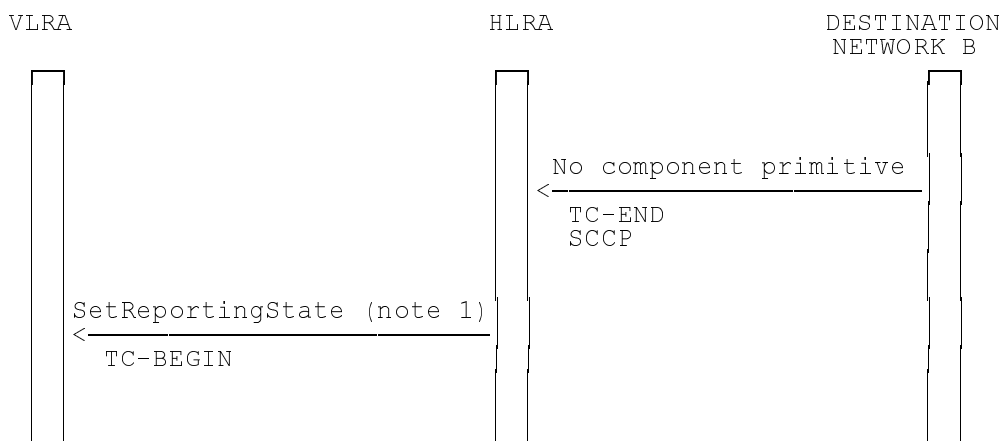

NOTE 1 If the monitoring function is active in VLR A and all outstanding CCBS Requests have been deactivated, the HLR A sends SetReportingState to deactivate the monitoring function (see GSM 03.93).

Figure 6.7: Signalling flow for normal dialogue end

The normal ending of CCBS dialogue from the B-side is carried by TC-END. The SCCP addressing parameters on the SSAP interface shall be as shown in table 7.3.

6.3.2 CCBS Cancel Invocation (from A-side)

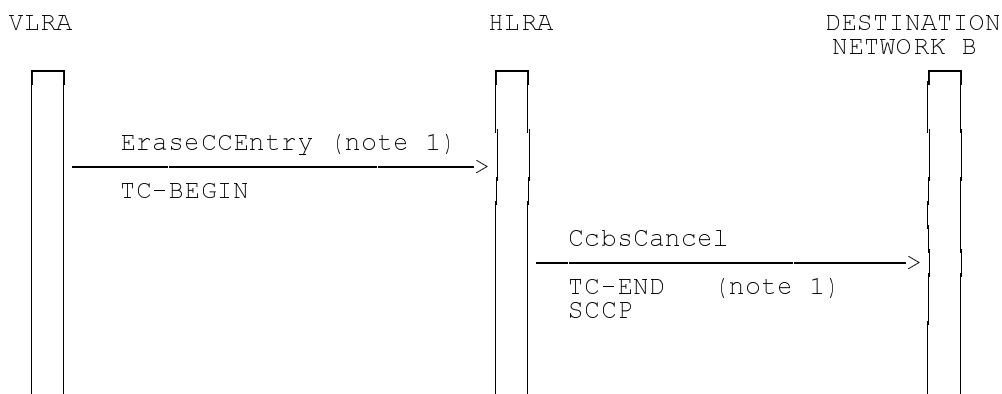

NOTE 1 Where all outstanding CCBS Requests have been deactivated, CCBS Cancel is sent to each corresponding Destination Network B with the appropriate Destination Network B E.164 Called Party Address (see GSM 03.93, GSM 04.93).

Figure 6.8: Signalling flow for CCBS Cancel Invocation (from A-side)

The CCBS Cancel Invocation from the A-side is carried by TC-END. The SCCP addressing parameters on the SSAP interface shall be as shown in table 7.2.

6.3.3 CCBS Cancel Invocation (from B-side)

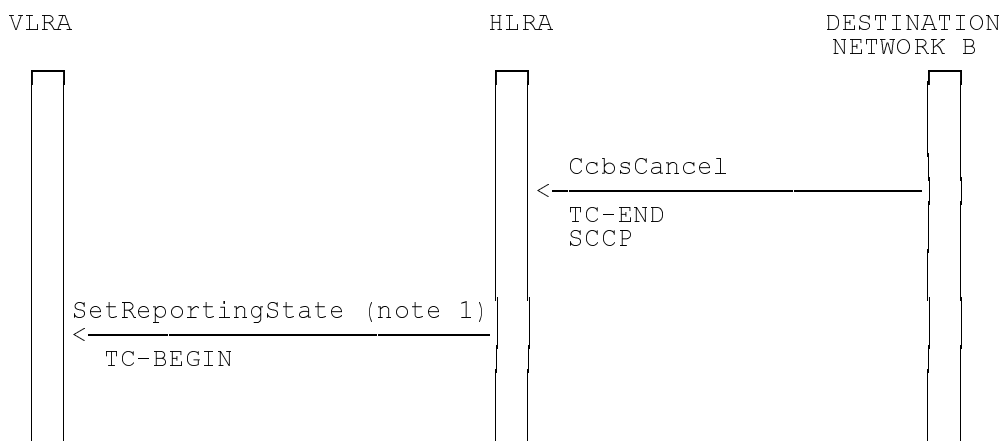

NOTE 1: If the monitoring function is active in VLR A and all outstanding CCBS Requests have been deactivated, the HLR A sends SetReportingState to deactivate the monitoring function (see GSM 03.93).

Figure 6.9: Signalling flow for CCBS Cancel Invocation (from B-side)

The CCBS Cancel Invocation from the B-side is carried by TC-END. The SCCP addressing parameters on the SSAP interface shall be as shown in table 7.3.

6.3.4 CCBS Request Error

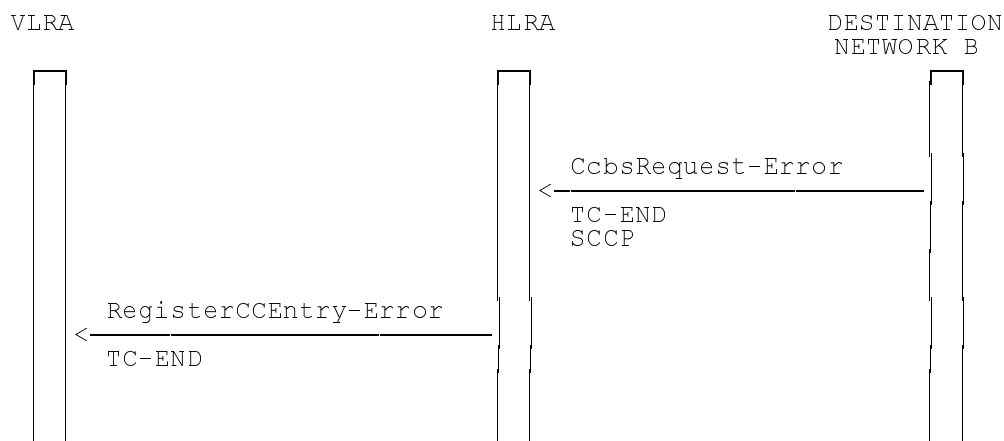

Figure 6.10: Signalling flow for CCBS Request Error

The CCBS Request Error is carried by TC-END. The SCCP addressing parameters on the SSAP interface shall be as shown in table 7.3.

7 Addressing of SCCP layer messages on the SSAP interface

The SCCP layer addressing for messages on the SSAP interface is described.

7.1 Use of SCCP

Clarifications and restrictions on the use and coding of the main SCCP parameters impacted by CCBS on the SSAP interface are indicated. See ETS 300 356-18 and the associated references for the full specification on the use of SCCP on the SSAP interface. The SCCP routing on the SSAP interface shall be based on the Global Title (GT) translation mechanism as for routing on the international interface. GT addressing shall be used for inter and intra PLMN signalling. This allows any impact of other network features e.g. Mobile Number Portability to be minimised.

7.2 Addressing of messages at the originating PLMN

7.2.1 TC-BEGIN message from the originating network HLR

The relevant SCCP parameters in the first message from the HLR A transporting TC-BEGIN are shown in table 7.1. All other SCCP parameters shall be as indicated in ETS 300 356-18.

Table 7.1: SCCP parameters used by HLR A for TC-BEGIN

SCCP PARAMETERS for the message transporting TC-BEGIN	PARAMETER VALUE
CdPA-Called Party Address	E.164 number of the Called Party. This may be in either international or national E.164 format, see subclause 7.4.1. It is derived from the translatedB-Number parameter which is available from the CCBS application in HLRA, see RegisterCCEnt in GSM 09.02.
CgPA-Calling Party Address	E.164 number of HLR A. This may be in either international or national E.164 format, see subclause 7.4.1.
SSN- Subsystem Number	0000 1011 (See ETS 300 356-18)
TT- Translation Type	0001 0001 (See ETS 300 356-18)
Other SCCP Parameters	See ETS 300 356-18

7.2.2 TC-CONTINUE, TC-END messages from the originating network HLR

The relevant SCCP parameters in the subsequent messages from the HLR A transporting TC-CONTINUE and TC-END are shown in table 7.2. All other SCCP parameters shall be as indicated in ETS 300 356-18.

Table 7.2: SCCP parameters used by HLR A for TC-CONTINUE, TC-END

SCCP PARAMETERS for the message transporting TC-CONTINUE, TC-END	PARAMETER VALUE
CdPA-Called Party Address	The Called Party Address is the E.164 address of the calling entity in the destination network that was received in the first response message from the destination network (note 1).
CgPA-Calling Party Address	E.164 number of HLR A. This may be in either international or national E.164 format as used in the message transporting TC-BEGIN, see subclause 7.4.1.
SSN- Subsystem Number	0000 1011 (See ETS 300 356-18)
TT- Translation Type	0001 0001 (See ETS 300 356-18)
Other SCCP Parameters	See ETS 300 356-18
NOTE 1 If the destination network is a GSM PLMN, this is E.164 number of HLR B.	

7.3 Addressing of messages at the destination PLMN

7.3.1 TC-CONTINUE, TC-END messages from the destination network HLR

The relevant SCCP parameters in the first and subsequent messages from the HLR B transporting TC-CONTINUE and TC-END are shown in table 7.3. All other SCCP parameters shall be as indicated in ETS 300 356-18.

Table 7.3: SCCP parameters for TC-CONTINUE, TC-END used by HLR B

SCCP PARAMETERS for the message transporting TC-CONTINUE, TC-END	PARAMETER VALUE
CdPA-Called Party Address	The Called Party Address is the E.164 address of the calling entity in the originating network that was received in the first message transporting TC-BEGIN from the originating network (note 1).
CgPA-Calling Party Address	E.164 number of HLR B. This may be in either international or national E.164 format, see subclause 7.4.2 (note 2)
SSN- Subsystem Number	0000 1011 (See ETS 300 356-18)
TT- Translation Type	0001 0001 (See ETS 300 356-18)
Other SCCP Parameters	See ETS 300 356-18
NOTE 1	If the originating network is a GSM PLMN, this is E.164 number of HLR A.
NOTE 2	The E.164 number of HLRB is used as this allows any impact of other network features to be minimised.

7.4 Number formats of the SCCP address parameters

The Called and Calling Party Address information in SCCP should be in international E.164 format. Optionally national format E.164 addresses may be used in SCCP for routing of national traffic. For this, the HLR has to modify the addresses which are in international E.164 format to a national E.164 format. If a national format E.164 option is used, all involved network nodes in a given country (i.e. the originating network, any transit networks and the destination network) need support that option. As negotiation is not possible, the option selected by the originating network shall determine the addressing used for all messages which are a part of a single dialogue.

7.4.1 Originating PLMN

The Called and Calling Party Address information in SCCP should be in international E.164 format.

The originating network HLR A may use the SCCP Called Party Address in national E.164 format if the called destination (as indicated by the translatedB-number) is in the same country as HLR A.

The originating network HLR A may use the SCCP Calling Party Address in national E.164 format if the called destination (as indicated by the translatedB-number) is in the same country as HLR A.

The originating network HLR A shall ensure that the SCCP Called and Calling Party Addresses are either both in international format or national format.

7.4.2 Destination PLMN

The Called and Calling Party Address information in SCCP should be in international E.164 format.

The destination network HLR B may use the SCCP Called Party Address in national E.164 format if the originating network is in the same country as HLR B.

The destination network HLR B may use the SCCP Calling Party Address in national E.164 format if the originating network is in the same country as HLR B.

The destination network HLR B shall ensure that the SCCP Called and Calling Party Addresses are either both in international format or national format.

Annex A (informative): Status of Technical Specification GSM 09.13

Status of Technical Specification GSM 09.13		
Date	Version	Remarks
May 1998	version 0.0.0	First draft
June 1998	version 0.1.0	Revision 1. Various editorial changes made. Open issues marked as {FFS} Version 0.1.0 - in Tdoc 98P151, from SMG 3 Plenary, Chester, UK.
June 1998	version 0.1.1	GSM 09.13 to SMG#26 for first information and to SPS1
July 1998	version 0.2.0	GSM 09.13 to SMG3 WPB, Stuttgart 10 - 14 August 1998.
August 1998	version 0.3.0	GSM 09.13 to SMG3, SMG3 WPC., September 1998.
September 1998	version 0.4.0	GSM 09.13 to SMG3, September 1998.
October 1998	version 2.0.0	To SMG#27 for approval
October 1998	version 6.0.0	Specification approved by SMG#26 for Release 97
Text and figures: word 6.0 Stylesheet: etsiw_70.dot Rapporteur: Sunil Chotai (Cellnet)		

History

Document history		
V6.0.0	October 1998	Publication